



PFAFF
INDUSTRIAL



PEGASUS

VETRON

TYPICAL

TÖÖSTUSLIKUD ÕMBLUSMASINAD.



VARUOSAD ERINEVATELE ÕMBLUSMASINATELE :

PFAFF, JUKI , PEGASUS, , DÜRKOPP, BROTHER, TYPICAL jm.



MUUD TEENUSED :

- Õmblusmasinate ja triikimiseseadmete hooldus, remont
- Rõivahooldusmärkide trükkimine
- Paigutusjooniste väljatrükk

**ERINEVAD NÕELAD tööstuslikele ja kodumasinatele.
SCHMETZ, ORGAN**



Nööpnõelad



Peenikesed nõelad. 30 x 0,6mm
Karbist ~ 600 tk.

Nööpnõelad klaaspeaga.



Pikad, tugevad nõelad
50mm x 0,76mm. Karbis 100 tk.

Õmblusnõel



Suure silmaga, peenike nõel
16 tk.

KÄÄRID

Lai valik kääre juurdelõikuseks, õmblus - ja tikkimistöodeks



KAI (Jaapan)

<https://www.kai-europe.com/>



KRETZER FINNY (Saksa)

<https://www.kretzer.de/>

Vaata ka meie laos olevate kääride kataloogi:

[KÄÄRIDE KATALOOG.pdf](#)

Elektriline kuumlõikur Saksa firmalt HSGM. Võimsus 60W

PAELTE, LUKKUDE, TAKJA, NÖÖRIDE ja teiste sünteetiliste materjalide lõikamiseks.
Suur valik erinevaid terasid, mida saab kasutada paljudes valdkondades.



Tera 29mm



Tera 45mm



Tera 90 mm



PLIIATSID, KRIIDID

Kriidipliiats harjaga, peenike 14cm
valge. sinine.roosa



Kriidipliiats harjaga, peenike 17 cm kollane.



Kriidipliiats, jäme 17cm

Värvid: must, valge, kollane, tume punane



Isekustuvad pliiatsid :

roosa 1-2 päeva

lilla 2-3 päeva

Eemaldatav vee või kustutuspliiatsi abil.



Veega eemaldatav marker. Sinine



Isekustuv pliiats, valge. 1-4 päeva



Kustutuspliiats. Eemaldab roosa ja lilla pliiatsi jäljed.

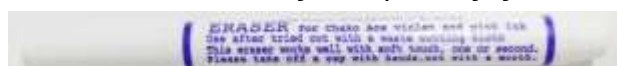

Pliiats nahale. HÕBE. Vahetatava süsiga.

Saadaval ka hõbesüsid.

Kriidrollerid, kriidipulbriga täidetavad

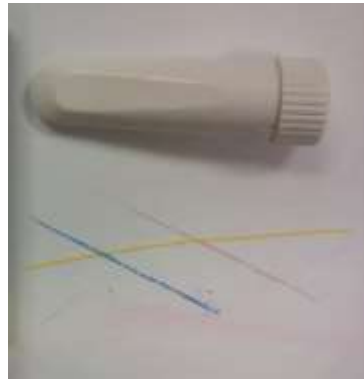

Kriidrollerite täitepulbrid



2 x2,8 gr Värvid: valge, sinine, kollane, roosa



50 gr Värv: valge

Kriidipulber 1KG



Värvid: kollane, punane, valge, sinine

Kriidpliats vahetatavate süsidega



KRIIDIPLIATSI SÜSID 12 tk./KARP



Punane, valge, kollane, sinine, assortii

KRIIDID

SAVIKRIIT: sinine, valge, punane, kollane, roosa



VAHAKRIIT: sinine, valge, punane, kollane

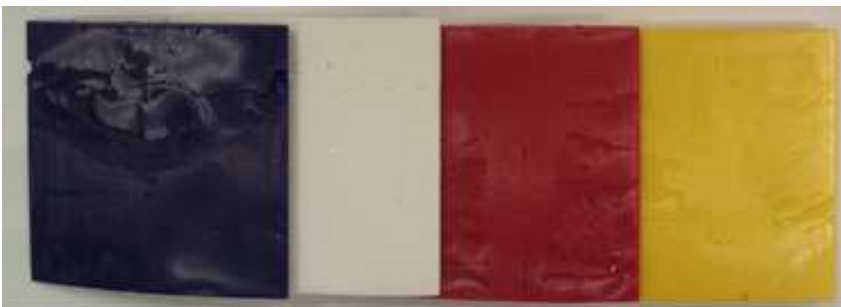

ISEKUSTUV KRIIT. Valge 2-5 päeva olenevalt materjalist
Kriidi jälg hahtub kiiremini triikimisel.

Kriidi teritaja



Kriidipliatsi komplekt.

Komplektis: pliats, süsid(16tk), pliatsi teritaja.

Pliatsi süsid (16tk)



MÕÕDULINDID

1.50 m



1.50 m (plastik ots 10cm)



1.50 m ja 2.00 m



MÕÕDULINT VEDRUGA 1.50 m



MÕÕDULINT VEDRUGA 3 m



MÕÕDULINT LIIMIGA 1.50 m Pakis 2 tk.



MÕÕDULINT LIIMIGA 20 m

Oranz- paremalt vasakule



Kollane –vasakult paremale



MÕÕDULINT METALLIST 10 m

Vasakult paremale ja paremalt vasakule



MÕÕDULINT METALLIST LIIMIGA 5 m

Vasakult paremale



LEKAALID, JOONLAUAD

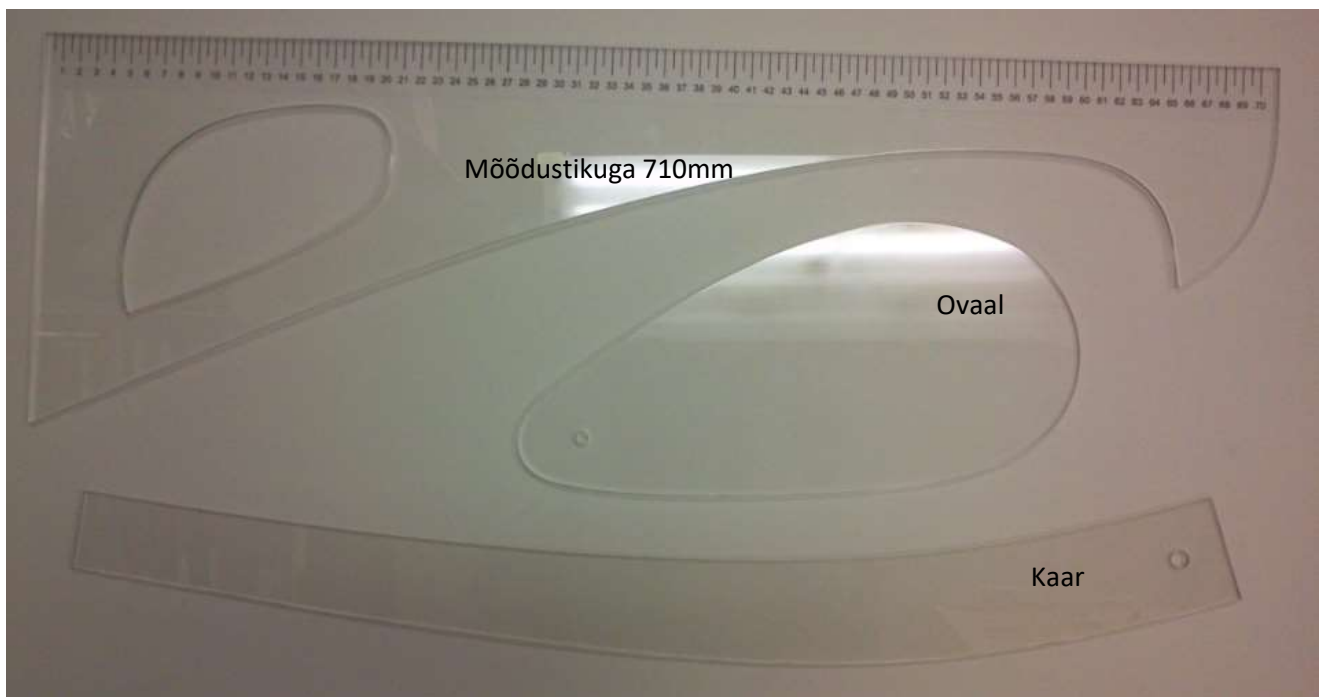

KÄEPIDEMED lekaalide joonlaudade vm. liigutamiseks



JOONLAUD täketega 21 cm



JOONLAUD õhukesest metallist. Laius 13mm **Pikkused : 15cm, 20cm, 30cm, 50 cm.**



JOONLAUD, alumiiniumist .Laius 45mm Pikkused: 50 cm, 100 cm, 150cm , 200cm, 250cm

Tagaküljel libisemisvastane kumm.

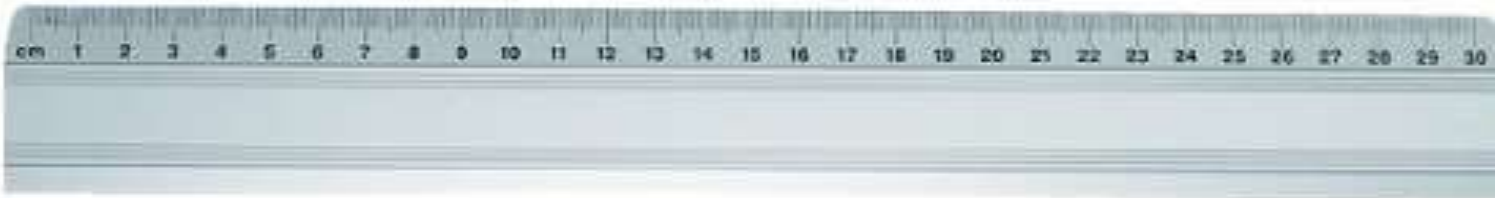

Kruvikeerajad, pintsetid, pintslid jm.

Nõela kruvikeeraja 6-kant, pikkus 13 cm



Yamato \varnothing 1/16''

Rimoldi \varnothing 1,5mm



Kruvikeeraja 6-kant \varnothing 1,5mm



Kruvikeeraja 6-kant \varnothing 2mm, pikkus 18 cm



6-kant \varnothing 3mm, pikkus 16,5 cm



Lapik ots 10 cm



Puidust käepide, lapik ots 16 cm



Plastik käepide, lapik ots 25 cm.



Puhastuspintsel harjaga, traadist vars 16 cm



Puhastuspintsel 19 cm



Naaskel puidust käepidemega. Pikkus 11 cm



Nööpimise abivahend. Pikkus 17,5 cm



Pintsetid. Kõverate otstega, otsad rihveldatud 16 cm



Pintsetid. Sirgete otstega, otsad rihveldatud 13 cm



Niidistaja, lapik



Niidistaja, pika varrega 16 cm



HARUTAJAD

191 12,5 cm



111R 9 cm



4511 11 cm



4510 7 cm



KÄSITÖÖ NOAD.

Karusnaha- ja naha nuga. Roostevabad terad diagonaalselt pooleks murtavad.



Noad harutamiseks, nahale. 13,5 cm.

Kõvera teraga



Sirge teraga



Nuga-skalpelli vahetatavate varuteradega. 15 cm



ABRASIIVNÖÖRID erinevate lihvimistöõde jaoks (hammastikud, nõelaplaadid..)
Nöörid 0.6mm, 0.8mm....-2.1mm



TEEMANTVIILID (5 tk. komplektis)



MAGNETID, PIIRAJAD



2,5 cm x 2,5 cm



5 cm x 2,5 cm



6 cm x 3 cm

Magnet nõeltele. Ovaalne 10,5 cm x 7,5 cm x 3 cm



Magnetplaat, õhuke 16 cm x 9 cm



Nahast veorihm õmblusmasinale.

6mm ja 8mm



Polyuretaanist rihm. 6mm ja 8mm



Rihma ühendus.



ÕLI õmblusmasinatele , overlokkidele ,tikkimismasinatele.

Tarnime õli 1 L pudelis ja 5 L kanistris



125 ml

Õlikannud



100 ml



90 ml



50ml

SPIRIT OL37 Silikonõli niidile. 1 L

Värvusetu,lõhnatu.Silikooni sisaldusega.

Muudab pinnad libedamaks.

Sobib ka erinevatele nugadele, ketastele, lintidele.



Niidi õlitaja

Kinnitub õmblusmasina külge magnetiga.

Anumas , kust niit läbi jookseb on silikoonõli (**spirit OL37**) . Aitab ära hoida niidi ülekuumenemist ja katkemist.

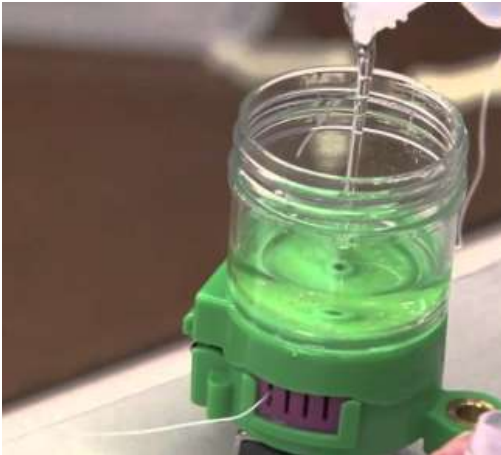

ÕLI erinevatele PÜSTNUGADELE 1 L Eastman, Wolf, Maimin, KM, Dayang jm.



TEFLON LIIMIGA. Laius 5 cm



Paksus 0,13 mm



Paksus 0,5 mm

TEFLON LIIMIGA

Laius 100 cm



Paksus 0,13 mm

TEFLON LIIMIGA, ANTISTAATILINE

Laius 100 cm



Paksus 0,13 mm

TEFLON ILMA LIIMITA

Laius 100 cm



Paksus 0,13 mm

TAJIMA tikkimismasinad, raamid. Varuosad.

<http://www.tajima.com/>



Tubular Frame
(550mm × 595mm)



Cap Frame 2
(75mm × 360mm)



Border Frame
(550mm × 600mm)



Tikkimisniidid, tikkimise aluskangad MADEIRA

Rohkem infot : <https://www.madeira.com/>



MADEIRA NIITIDE VÄRVIKAARDID.

Link kodulehele

<https://www.madeira.com/embroidery-solutions/service/support/shade-cards>



ÕLITAJA. Peene süstlaga pääseb kergemini ligi erinevatele õlitamist vajavatele masina osadele.



Niidirulli alus

Sobib nii 100m kui 5000m rullide hoidmiseks



Niidirulli võrk



Hoiab niiti tikkimise ajal stabiilse pinge all. Eriti kasulik FS (metallik) niitidega tikkimisel.

Spray liim 500ml.

Detailide ajutiseks kinnitamiseks aluskangale. Liim kaob mõne tunni pärast ega jäta jälgi.



Õlikann peenikese plastikust otsaga.200 ml



Niidipinge mõõtja



Poolniidi pinge mõõtja



Poolikerija.

Mõõdud 21 x 15 x 11 cm, kaal 3kg.



Pooliniit 15 000m.Valge ja must

EELKERITUD ALUSNIIDID. Magnetiga ja ilma.



ETIKETIMATERJALID ja FOOLIUMID TERMO-ja HOT STAMP PRINTERITELE

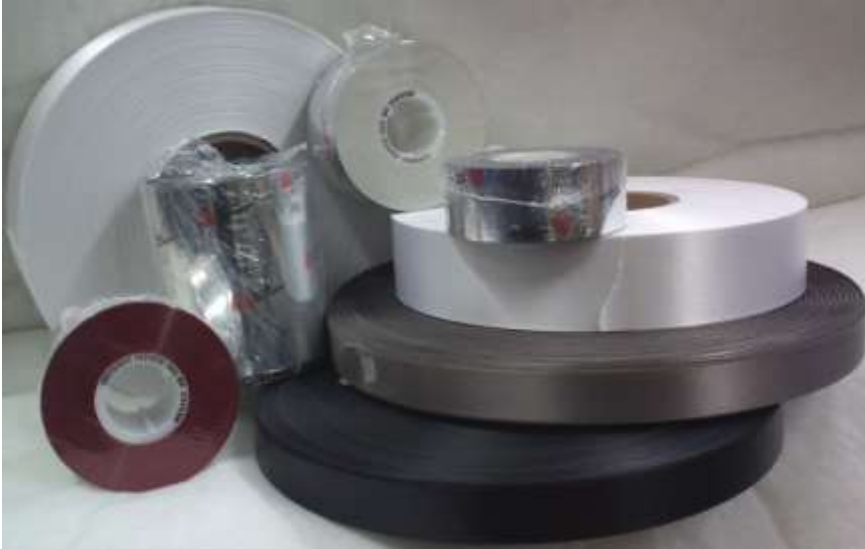

Trükitud, kootud etiketid

- Valmistame etikette õmblustööstusele, müüme etikettide trükkimiseks erinevaid materjale ja printereid.



ETIKETIPÜSTOLID, NÕELAD .DENNISON



Standard püstol



FINE (peenikestele kinnititele)



10312-0



ERINEVAD PLASTIK KINNITID



Standard. Natural.

Pikkused: 15mm, 20mm, 40mm, 65mm



Karbis 5 000 tk.

Standard, must.

Pikkused : 20mm, 40mm



Karbis 5 000 tk.

Standard, roheline

Pikkus : ainult 20mm



Karbis 5 000 tk.

Peenikesed kinnitid. FF Ainult valged.

Pikkused: 7 mm, 13 mm, 20 mm, 25 mm, 40 mm, 65 mm.

Karbis 10 000 tk.

Konksud. Ainult valged. Pikkus 19mm.



Karbis 5000 tk.

Käsitsi kinnitatavad .

Valge. Pikkused :75 mm ja 125 mm.

Must. Pikkused: 75 mm ja 125 mm



Karbis 5000 tk.

Karbis 5000 tk.



LADEMEŅĒLAD

Lademenõel 3 x 30mm

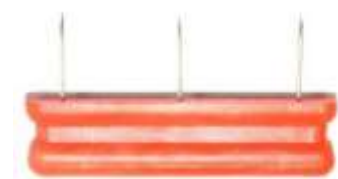

Lademenõel 3 x 40mm

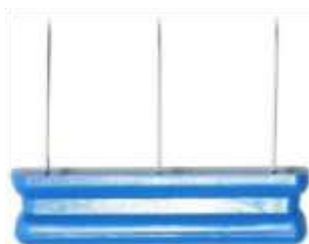

Lademenõel 3 x 60mm



Lademenõel, kolmnurk 3 x 40mm



Lademenõel 60mm



LADEME KLAMBRID



CL4AA Laius 120mm,ava/kõrgus 80 mm

CL6AA Laius 120mm,ava/kõrgus 140 mm

CL8AA Laius 120mm,ava/kõrgus 200 mm



195S Laius110mm, ava/kõrgus 50 mm



EMCL6 Laius100mm, ava/kõrgus 50 mm

584 Laius 125mm,ava 35mm

34 Laius 75mm,ava 25mm



CL12 S Laius 60mm,ava 50mm,pikkus 85mm

C12 Laius 30mm, ava 40mm, pikkus 80mm



CLC11 Laius 65mm,ava 120mm, pikkus 220mm

CLC19 Laius 50mm,ava 70mm,pikkus 135mm



KEEMIA

PUHASTUSVEDELIK Reliant 500 ml

Sobib erinevatele dubleerpresside ja konveieri lintidele. Eemaldab kinnikleepunud mustuse. Kaitseb pindu.

ROLLAX Puhastuspulber silikooniga. 250 gr.

Liimijääkide eemaldamiseks dubleerpresside lintidelt,kuumpresside plaatidelt, samuti triikraudadelt. Kasutamistemp. Kuni +240°C Sobib hästi erinevatele teflonpindadele,kaitseb pindade kokkukleepumise ja niiskuse eest.Ei sisalda mürgiseid keemilisi ühendeid. Ei kahjusta kangast.

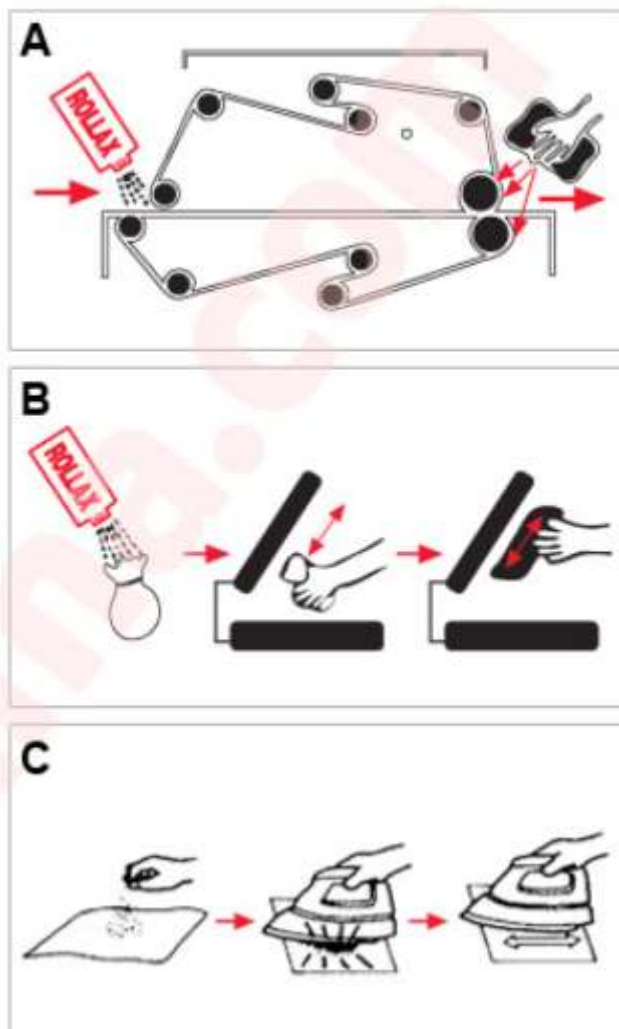



ANTISTAATIK TAKTER 410ml

Eemaldab staatilist elektrit, hoiab ära tolmu kogunemist masinate elektroonilistele osadele.

Eriti sobilik kasutada erinevate masinate juures millel on otsene kontakt töödeldava materjaliga, näiteks termoprinterid, tikkimismasinad, skännerid jm.

PLEKIEEMALDAJAD

Pihustamisel moodustub valge kuiv pulber, mis imab endasse õli, tindi, rasvapekid Puuvillast, siidist, villast sünteetilistest kangastest esemete puhastamiseks

Pulimak 1 400ml



Pulimak2 STRONG 400ml



SPIRIT77 400ml

Efektívne vahend värskete plekkide eemaldamiseks rõivastelt, mööblikangastelt, vaipadelt.

Sobib kasutamiseks ka kodus majapidamises.



SPIRIT 2 Vaseliinõli.400ml

Värvusetu ja lõhnatu. Ei jäta jälgi.Kõikidele masina liikuvatele osadele.Kaitseb oksüdeerumise ja roostetamise eest.Aitab ära hoida plastik-ja kummimaterjalide kokkukleepumist.



SPIRIT 3-EXTRA 500ml

Silikonmääre.

Kiirelt kuivav.Ei jäta õlist pinda. Aeglustab roostetamist ja tagab masina liikuvate osade sujuva töö. Sobib hästi lõikeseadmetele ja erinevatele lõiketeradele.

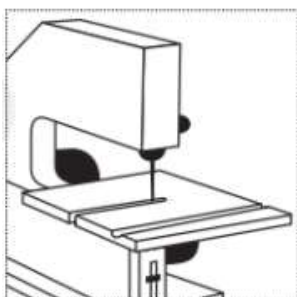
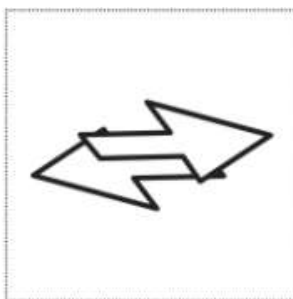
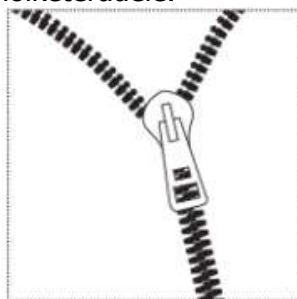

SPIRIT5 Aerosoolliim.500ml

Sobib kasutatada kanga,papi,plastiku,kile jm.materjalide ajutiseks

kinnitamiseks.Liimitavad pinnad on kergesti üksteisest eraldatavad ja ühte materjali võib liimida mitmeid kordi.

Asendamatu just tekstiilitööstuses näit. lõigete paigutusel,ja tikkimisel kasutatavate materjalide liimimisel.

SPIRIT5 STRONG. 500ml tugevama efekti saavutamiseks.



SPIRIT6 400ml

Lahustit sisaldav puhastusvahend. Kiiresti imenduv lahustisegu.

Sobib hästi mustuse, õli, tahma ja liimijälgede eemaldamiseks masinatelt ja tööriistadelt. Eemaldab hästi ka roostet.

Sobib hästi SPIRIT5 ja Spirit5 Strong jälgede puhastamiseks.



SPIRIT21 400ml

Sünteetiline määrdeaine. Värvusetu. Veekindel.

Eriti sobilik kõikidele liikuvatele ja suurt koormust nõudvatele masinaosadele, nagu hammasrattad, ketid, laagrid jne.



SPIRIT 25 400ml

Teflonit sisaldav kuiv määrdeaine. Hea nakkuvus, vett hülgav, ei määri. Hea tolmuvastane kaitse, eriti sobiv plastik- ja spoonpindadele (ladestuslauad, lintsaetööpinnad jne.) Kannatab temperatuuri kuni 300 C.

Talub nii aluselist kui happelist keskkonda.

VÄIKSEMAD KETASLÕIKURID

ALLSTAR SC 100K

KETASLÕIKUR, NUGA 50 MM 50W ALLSTAR



KM RS 50

KETASLÕIKUR, NUGA 50 MM 40W



GARUDAN HC1007

KETASLÕIKUR, NUGA 50 MM 45W/SC500, SUPRENA



EC-1 LÕIKUR Väike kerge käsilõikur. Kaal 220 gr.

Töötab nii akuga kui elektriga. 220V

Komplektis : lõikur, akulaadija, aku, alusega lõiketera.



MICO MB-60

KETASLÖIKUR AKUGA ,TERA 60 mm 200W

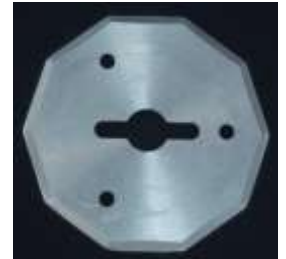

RK-70 Ketas 70mm -8 kant. Lade max. 25mm



160 W 10.8 V (Max. 12V) 1800 r/min

Aku : 1 Li-Ion 2.5Ah + 1 Li-Ion 5.0 Ah

RK-100 ja RK-125 KETASLÖIKURID AKUGA

160 W 10.8 V (Max. 12V) 1800 r/min

RK-100. Ketas 100mm. 8-kant. Lade max. 30 mm

Aku : 2 Li-Ion 5.0Ah

RK-125. Ketas 125mm. 8-kant. Lade max. 42mm

Aku : 2 Li-Ion 5.0Ah



RSD-100 KETASLÖIKUR ELEKTRILINE 300 W, lōikeketas 100 mm

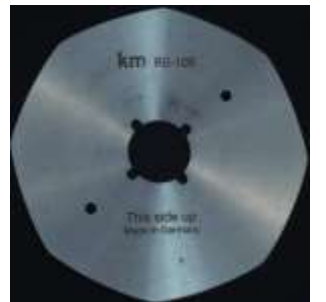

PÜSTLÕIKURID

- 5'' lademe kõrgus 9 CM
- 6'' lademe kõrgus 11 CM
- 8'' lademe kõrgus 16CM

DAYANG 5''

Ergonomic and easy to use, universal straight knife, equipped with automatic knife grinding device and lubrication system. Especially designed for cutting small amount of layers. Little weight (only 9 kg) makes it very handy and convenient to use which enables smooth knife conduct during cutting fine woven fabrics and knitwears. Suitable for initial cuts as well as for final cuts. Foot construction additionally facilitate knife maneuvering and minimize risk connected with moving of material layers. It has features such as steady run and precise work. Rating power 370W, 2.800 rpm, voltage 230V. Weight 9 kg.



DAYANG 6'' ja 8''

6''

Ergonomic and easy to use, universal straight knife, equipped with automatic knife grinding device and lubrication system. This model is available for cutting materials such as cotton, woolens, linen, silk, denim etc. Suitable for initial cuts as well as for final cuts. Foot construction additionally facilitate knife maneuvering and minimize risk connected with moving of material layers. It has features such as steady run and precise work.

Rating power 550W, 2.800 rpm, voltage 230V. Weight 15kg.

8''

The most popular, universal straight knife - cutting height 16 cm enables cutting both fine and heavy fabrics. Ergonomic and easy to use, equipped with automatic knife grinding device and lubrication system. This model is available for cutting materials such as cotton, woolens, linen, silk, denim etc. Suitable for initial cuts as well as for final cuts. Foot construction additionally facilitate knife maneuvering and minimize risk connected with moving of material layers. It has features such as steady run and precise work.

Rating power 550W, 2.800 rpm, voltage 230V. Weight 15kg.



LÖIKETERAD, NOAD, KÄIAKIVID jm.varuosad OTSALÕIKURITELE, LINTSAAGIDELE, KETASLÕIKURITELE, PÜSTNUGADELE. KM, EASTMAN, HOOGS, MAIER, KURIS jm.

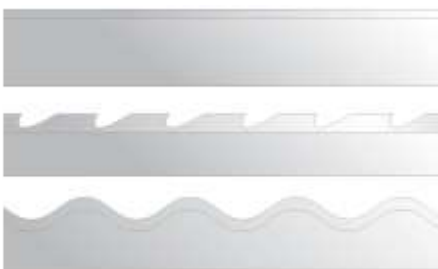

TERITUSLINDID erinevatele püstnugadele : EASTMAN, KM, Kuris, Wolf, Dayang jm.



JUURDELÕIKAJA TURVAKINDAD .

Roostevabast terasest metall turvakinnas.Reguleeritav randmepannal. Kinnast saab kasutada ümberpööratuna ka paremas käes.



XXS /pruun



XS/roheline



S/valge



M/punane



L /sinine

TRIIKIMSSEADMED. Tarvikud

AURUGENERAATORID.

ROTONDI MINI -3 Veepaak 2,3 liitrit



ROTONDI MINI-45 Veepaak 4,5 liitrit



MINI-6



IGOS-3



MINI -6 Veepaak 11 L.

IGOS - 3 Veepaak 8 L. Võimaldab töötada kahe erineva eraldi sisselülitatava auruseadmega.

Ühendatakse otse veesüsteemi.

TRIIKIMISLAUD vaakumiga.



VARRUKAPUKK

ROTONDI MINI-10

Vaakumlaud+ Aurugeneraator triikrauuga. Veepaak 4 liitrit.



MINI 10

ROTONDI 388/A

Vaakumlaud varrukapukiga.



TRIIKIMISLAUDADE KATTED



Auruhari-Speedy. Sobib ühendamiseks aurugeneraatoriga.

500W 230V



FN-200. Triikraud-aurutaja



DUBLEERPRESSID. Manuaalsed ja automaatsed.



Triikraud

ROTONDI EC-289



Triikraua alusmatt kummist



Teflontallad triikraudadele



ROTONDI EC-100 800 W

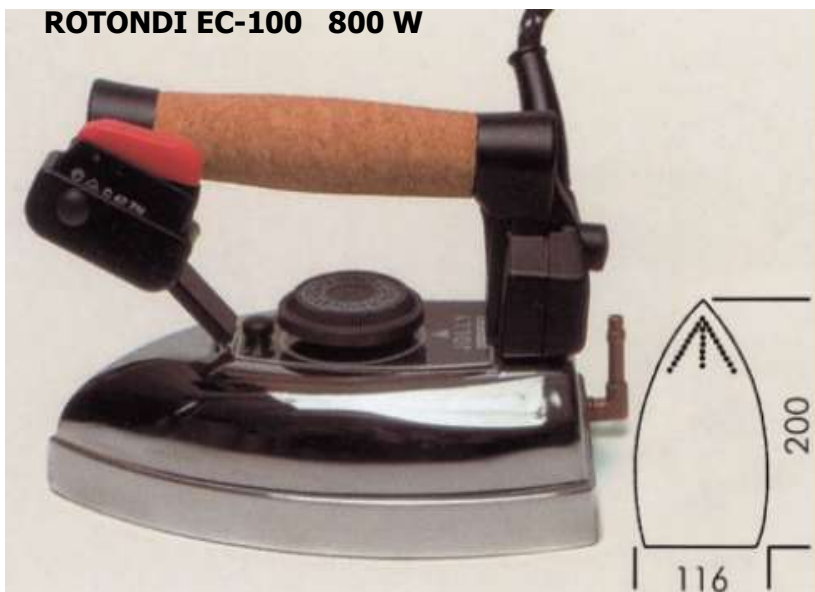

Balansiir triikraua ülesriputamiseks. Max 2 kg





Triikraua põhja puhastuspulk

VEEPEHMENDAJA (500ml)

Kasutatakse katlakivi neutraliseerimiseks aurugeneraatorites.

TRIIKIMISLAUA KATTEMATERJALID



Laius 1.70m

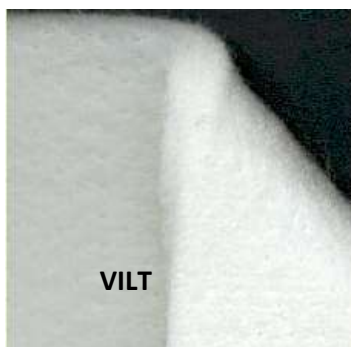

Paksus 6mm. Laius 1.30m



Laius 1.65m



Paksus 1mm. Laius 1.40m



Paksus 5mm. Laius 1.30m

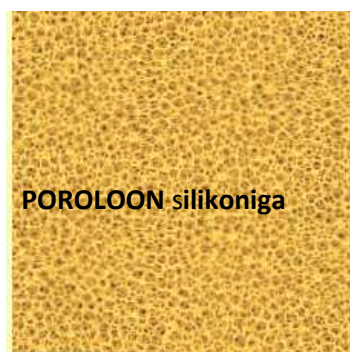

Paksus 6 mm. Laius 1.50m

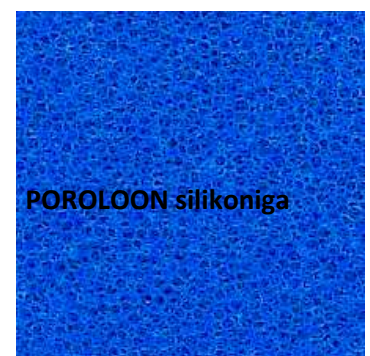

Paksus 10 mm. Laius 1.30m

Lademepuur SL-201



Puuri nõelad.

Pneumaatilised, manuaalsed termosirde pressid.



LAMBID



P996.70 LAMP LED
4,5W 500lm

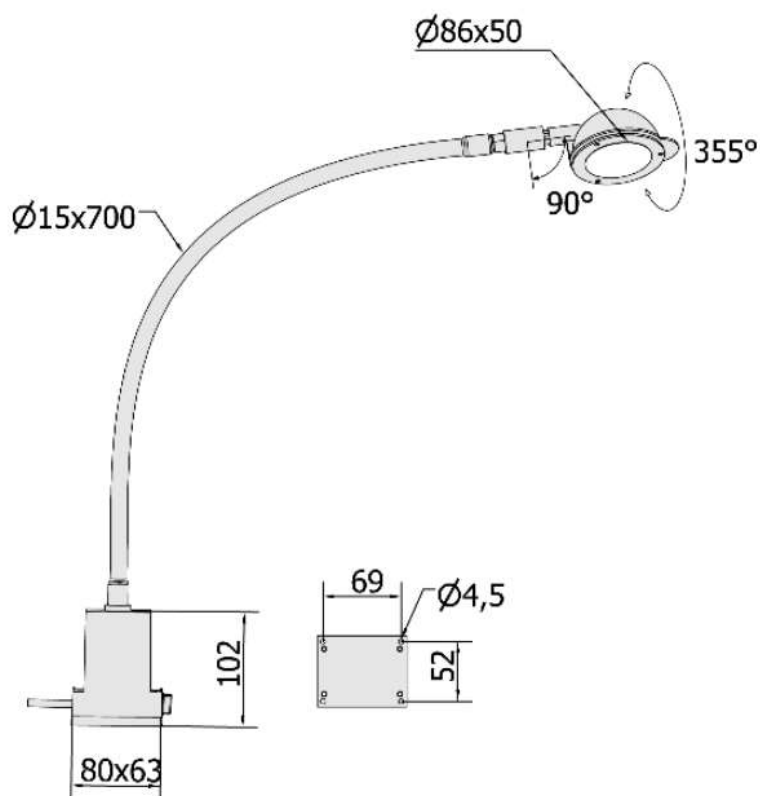

LAMP FLUORESCENT 9W P772/70



**VÄIKESED LED LAMBID
MAGNETIGA**

LAMP LED 1 W 3,2V
reguleeritav valgusvoog
K4LED 1W



LAMP LED 2 X 1W
3,2V reguleeritav valgusvoog
K4LED 2x1W



LAMP 2x3 LED 110V ~ 240V, 50/60 Hz, 0,5 W. Kinnitatakse magnetribaga kahele poole presstalda.



LAMP 1x 6-LED. 110V ~ 240V, 50/60 Hz, 0,5 W Kinnitatakse magnetribaga ühele poole presstalda.



LAMP 6-LED. U-kujuline Kinnitub magnetiga ühele poole presstalda.



LAMP 10-LED LIIGENDIGA+PAINDUV OSA 5 W. Laua külge kinnitatav.



LAMP 10-LED LIIGENDIGA 5W . Masina pea külge kinnitatav



LAMP 28-LED 2 W painduv vars . Masina pea külge kinnitatakse.



LAMP 30- LED 5 W, painduv vars. Laua külge kinnitatav



LAMP 28-LED PAINDUV VARS 6W ,Reguleeritav valgusvoog. Laua külge kinnitatav.



LAMP 20-LED. Magnetiga, painduv vars.

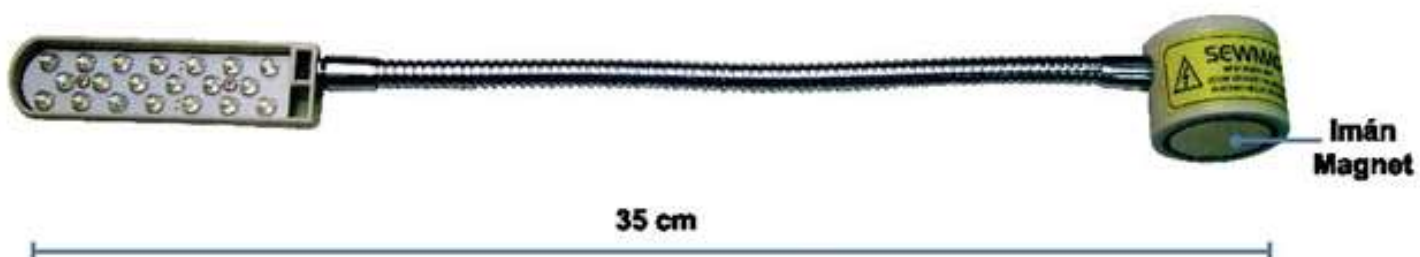

LAMP 9W LIIGENDIGA Masina pea külge kinnitav.



LASERID. OBS

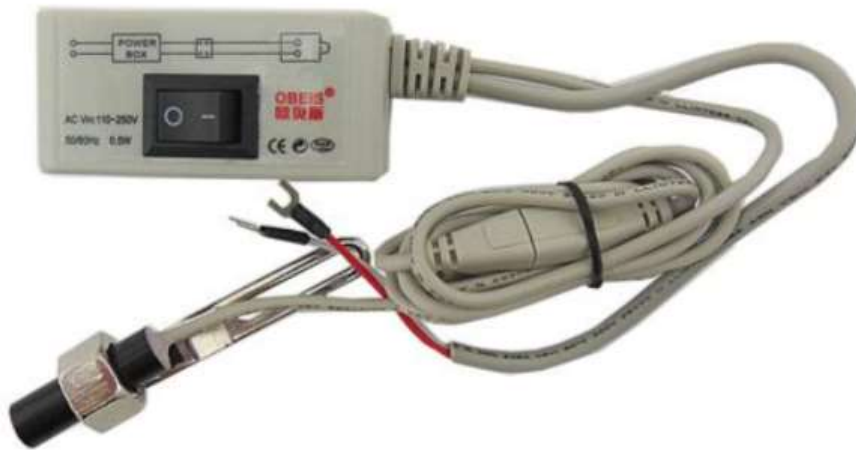
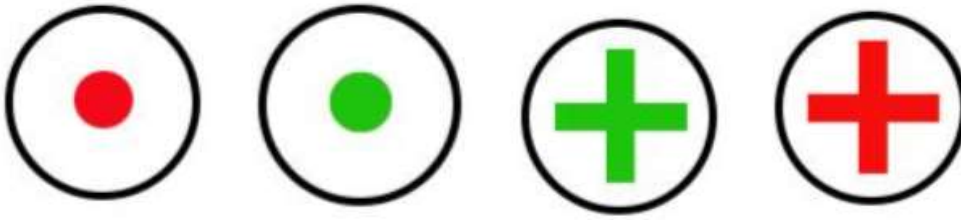

REGULEERITAV RÄTSEPA MANNEKEEN

NAINEN

36-48 (Saksa)

MEES

42 -54 (Saksa)

Käega



Ilma käeta



TOOLID



EVO 4

Vineerist iste.

Seljatoe kaugus reguleeritav.
Pneumaatiline tõste mehhanism.

Istme kõrgus max. 63 cm.
Lame, madal metallist jalg.



EVO 2

Polsterdatud iste.

Seljatoe kaugus reguleeritav.
Liikuv seljatugi.
Pneumaatiline tõste mehhanism.

Istme kõrgus max. 63 cm.
Lame, madal metallist jalg.

EVO2 PROFI

Polsterdatud iste, liikuva seljatoega.

Seljatoe kaugus, kõrgus reguleeritav
Pneumaatiline tõste mehhanism.

Istme **kõrgus max. 63 cm.**

Lame, madal metallist jalg



PRO BLACK



Polyuretaanist iste.

Pneumaatiline tõste mehhanism.

Seljatoe kõrgus ja kalle reguleeritav.

Istme kõrgus 53-78 cm. Olenevalt valitud pumbast.

Tugevdatud plastikust 5 haruline jalg.



Tools saab tellida ka ratastega



PRO BLACK Kõrge tool, jalatoega



Polyuretaanist iste.
Pneumaatiline tõste mehhanism.
Seljatoe kõrgus ja kalle reguleeritav.

Istme kõrgus max. 78 cm.

Tugevdatud plastikust 5 haruline jalg.
5 ratast.

Tugirõngas jalgade toetamiseks.

Toolil saab tellida ka ilma ratasteta



TOOLE: EVO 4, EVO 2, PRO BLACK saab komplekteerida vastavalt teie vajadusele.

Valida saab erinevate tooli osade vahel:

Tooli iste: vineer, pehme, poliüuretaan vaht.

Tõstepump : 53 cm, 63 cm, 78 cm

5-haruline jalg : madal metall, või tugev plastik.

Jalatugi/rõngas

Rattad või jala otsad (5tk. komplektis)

! Rattaid ja jalaotsi saab lisada ainult plastikust jalale.



**SYSTEM
PRO** bl



TL SIL Plastikust, aukudega iste.

Seljatoe kõrgus ja kaugus reguleeritav.

Pneumaatiline tõste mehhanism.

Istme kõrgus max. 53 cm. !

5 haruline tugevdatud plastikust jalg



LAOS VIIMASED SOODUSHINNAGA !

KANGA OTSALÕIKURID,VARUOSAD

Manuaalsed: DAYANG , SU-LEE Rööbaste pikkus 260 cm (standard).



Täisautomaatsed : DAYANG, SU-LEE Rööbaste pikkus 250 cm (standard) , 360 cm.



Erinevad varuosad otsalõikuritele.

PRESSTALLAD

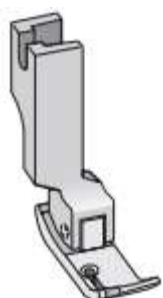

P360 -2mm

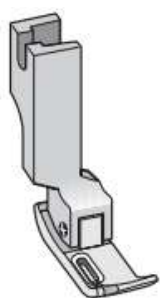

360-NF



P361-2mm



P361-NF



P363



P363-NF



P363V NF nl.vedu



351-11mm



351-NF



B1524-412 11mm



142058N 8mm

Teflontallad



T35/MT1



NT18



MT1-NF nl.vedu



T363



NT50



2-piirajaga

10977 2x6,4 X 1,6mm



1-piirajaga

12007 2x6,4 X 1,6mm



210569 15/7mm



503595 19/10mm



224158 4,8mm

Presstalla komplektid astuva tallaga masinatele (Juki, Dürkop, Pfaff)

Presstalla komplekt .Kitsas.Parem, vasak.

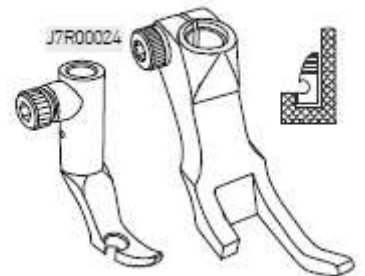

Presstalla komplekt piirajaga.Parem , vasak.

Keskmise suunajaga



Keeditalla komplekt.

Paela suunaja

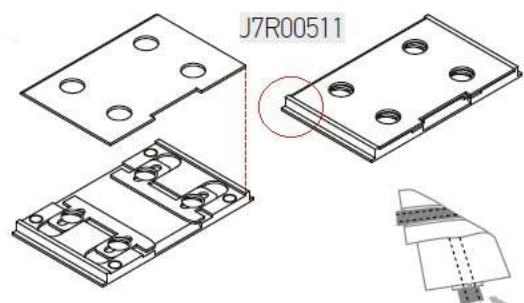

Keedritallad universaalmasinatele.

Parempoolne **P69R**. **P69R-NF**(nõelavedu)

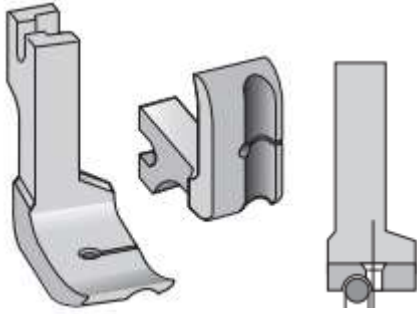

Vasakpoolne **P69L** **P69L-NF** (nõelavedu)

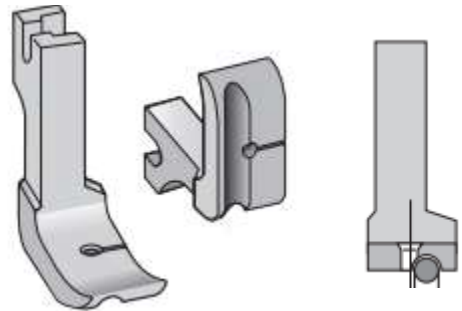

P230 Piiraja presstalla külge



120428 Piiraja, reguleeritav



GO195 Pööraja hoidja

Presstald reguleeritava piirajaga (vasak ja parem) **P723**

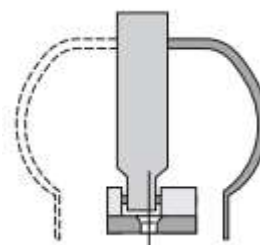
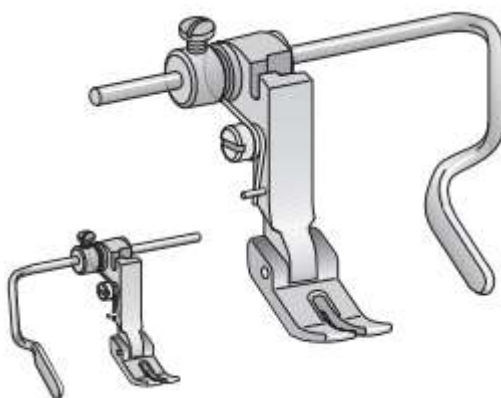

Kompenseerivad tallad

Tikkimistald parempoolse vedruuga **CR**

Tikkimistald vasakpoolse vedruuga **CL**

CR10,15,20,30,40,50,60,70,80,100mm

CL10,15,20,30,40,50,60mm

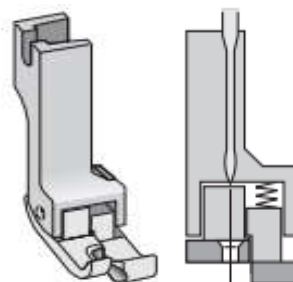
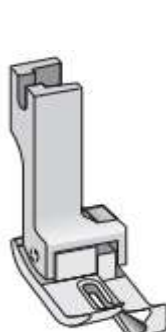
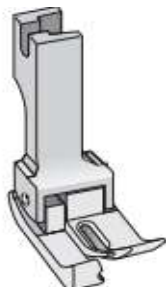
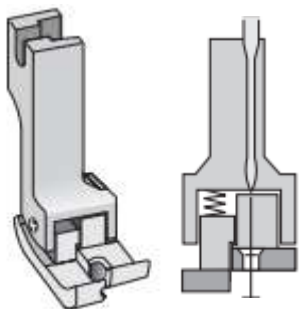

parem nl.vedu **CR-NF**

vasak nl.vedu **CL-NF**

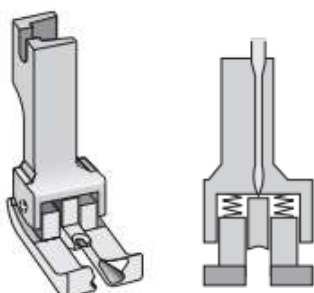

Tikkimistald kahepoolse vedruuga **CD**

221 1,6mm/vasak **210** 0,8mm/parem

Lukutallad

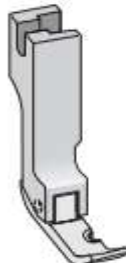
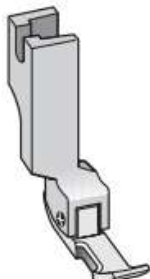
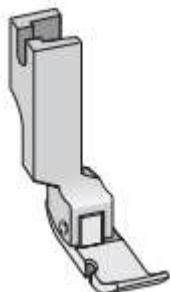

P36LN 5mm

P36L 8mm

P36LN-NF

P36N-5mm

P36 8mm

P36N-NF

Peitluku tallad



S518



S518-NF nl.vedu

Piirajaga presstallad



SP18 piiraja paremal



SP18-L piiraja vasakul

PIIRAJAD

NG-2000R Juhik, presstalla kruvi külge (parem)

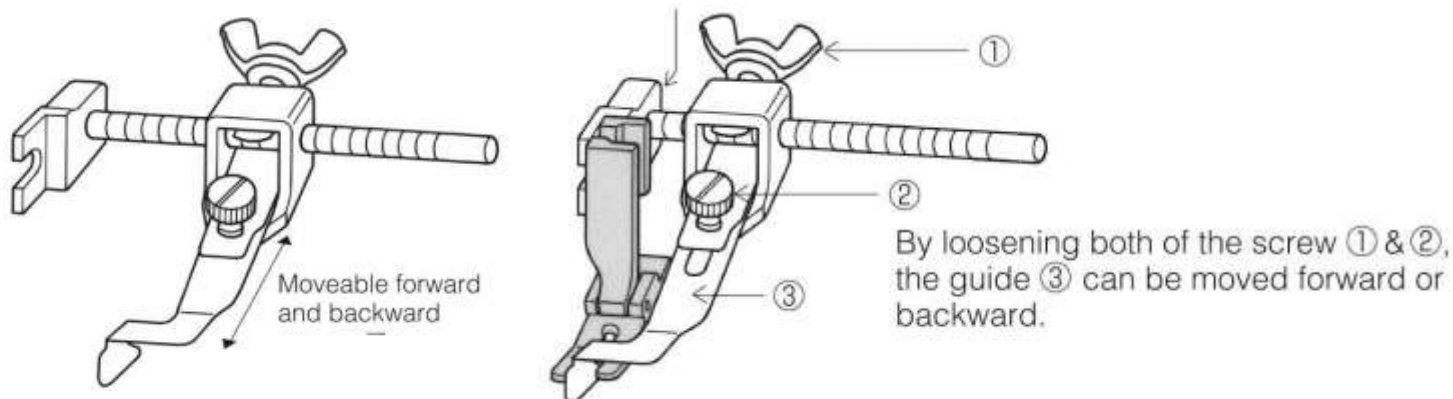

NG-190SN Piiraja, presstalla kruvi külge



GB-6PL (7035).Reguleeritav piiraja rulliga.

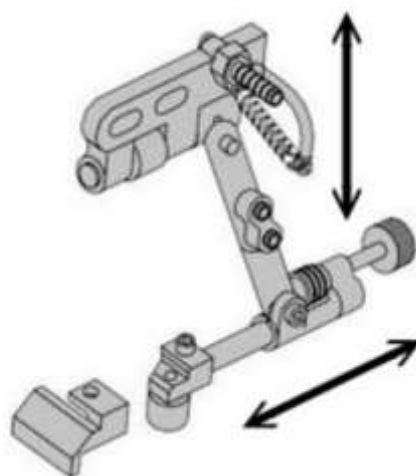

Pöörajate kataloog : http://www.rimoldiecf.com/sites/default/files/2_GA-GO.pdf

Lihtsamad pöörajad laos:

A4 Kant pooleks

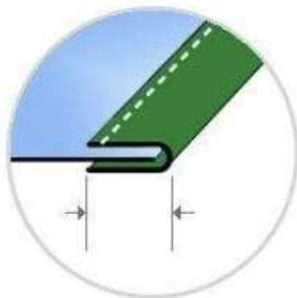
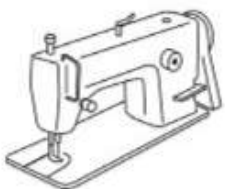

A10 S60 Kant topelt

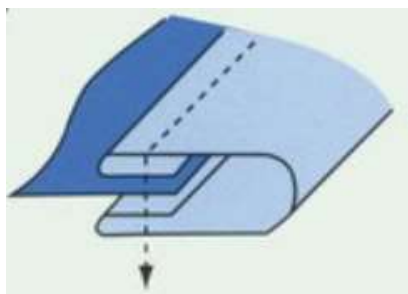
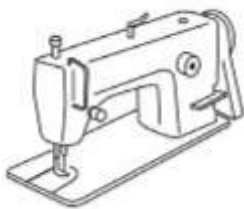

A11 S72 Serv topelt

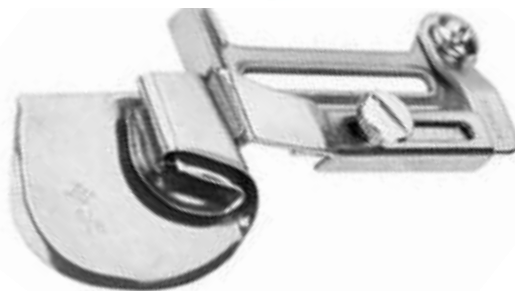
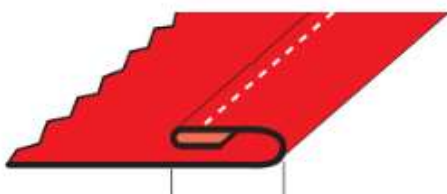

Kandipööraja astuva tallaga masinatele.

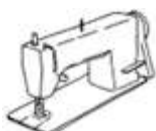

Eastman®

Pakume erinevaid juurdelõikuslahendusi firmalt **Eastman Machine Company**.

Eastman CAD- ja CAM-süsteemide müük, väljaõpe, hooldus, remont

- Erinevad juurdelõikusautomaadid (ühekihi lõikurid, lademe lõikurid)
- Ladestusmasinad, ladestuslauad, kangasööturid
- Plotterid ja digiteerimislaud
- Tarvikud ja varuosad



OPTITEX

Pakume *Optitex* tarkvaraprogrammi, mis on mõeldud rõivaste, mööbli ja aksessuaaride tootmisprotsessiks, alates tootearendusest kuni juurdelõikus protsessini välja:

- Lõike- ja tootedisain
- Lõigete digitaliseerimine
- Suuruste loomine
- 2D lõigete toomine 3D-sse
- 3D simulatsioon
- Tootekaardi koostamine
- Fotorealistlik 3D
- Kangale paigutamine
- Plotteriga jooniste välja plottimine juurdelõikuse tarbeks

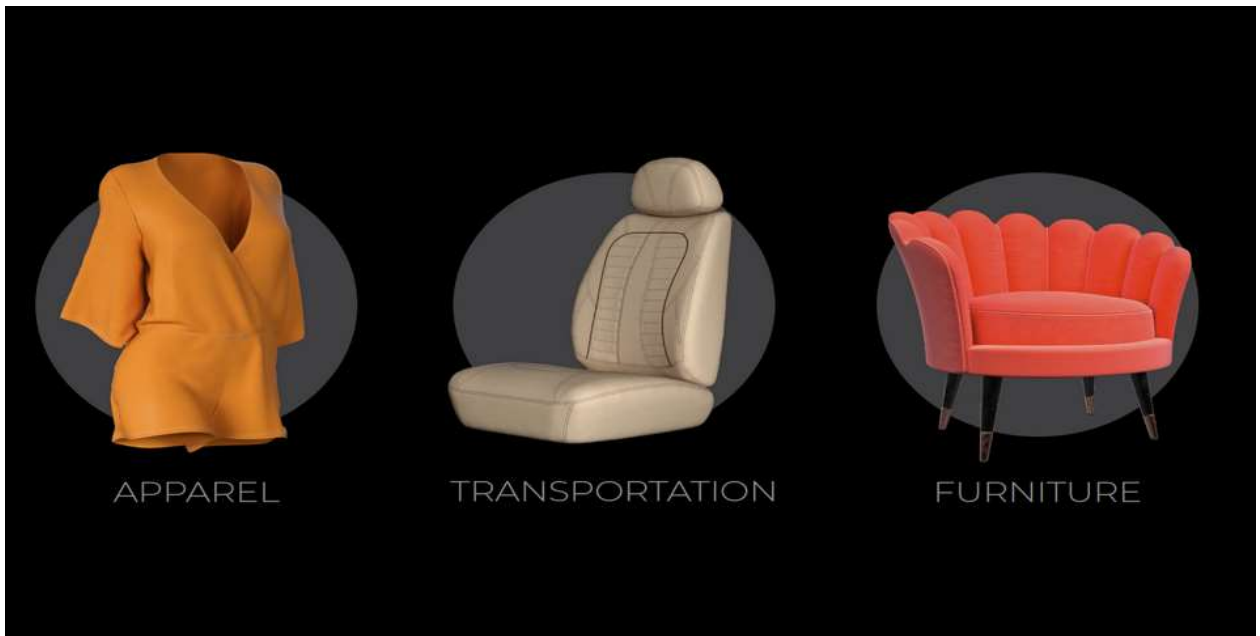

Teenused:

- Programmi koolitus ja tugi
- Mudelite digitaliseerimine ja suurendamine
- Mudelite ja paigutusjooniste väljatrükk
- Failide konverteerimine



KANGARULLIDE PLATVORMTÖSTUK, AKUGA.

Platvorm 120 cm

Tõstevõime kuni 65 kg

Tõste kõrgus 20 cm-150 cm



Juurdelõikuses kasutatavad paberid, kiled.

- Plotteripaber
- Liimiga plotteripaber
- Perforeeritud aluspaber
- Aluspaber
- Vahepaber
- Kartong
- Kile



Perforeeritud paber: 162 cm ,182 cm - 60gr/m²

Perforeeritud paber: 162 cm-75 g/m², 182 cm-90 g/m²

Vahepaber 162cm : 30gr/m²

Aluspaber 162cm : 40g/m²

Plotteri paber:

Ilma liimita :165cm -60gr/m²

Liimiga (SPT) : 165cm- 55gr/m²

Markeeritud, liimiga : 165cm- 55gr/m²



Kartong lekaalidele. Rulli laius 100cm 450gr/m²

Lademe kile . Antistaatiline .Paksus 15MY, Laiused: **200 cm, 215 cm**

LINTSAED : DAYANG, OSHIMA



Lintsae terad



ÕMBLUSMASINATE MOOTORID 550 W, 750 W. 220 V

Universaalsed, energiasäästlikud servomootorid.



Nöobikanna kerija.



MMS

MK 11
Classic

HIGH SPEED AUTOMATIC
BUTTON SHANK
WRAPPING MACHINE

The MK 11 is our world wide best selling automatic button wrapping machines which was designed in house and continues to be manufactured in our own UK factory.

360° bonding

The advertisement features a red and silver MMS MK 11 Classic button shank wrapping machine. It includes a logo with a button and the text 'MMS', a close-up of a button being wrapped, a close-up of a button shank being wrapped, and a circular inset showing the machine's internal mechanism with the text '360° bonding'. A small Union Jack flag is visible on the side of the machine.

Nöobikanna kerimise niidid firmalt MMS.





ÕMBLUSMASINA SAHTEL



NIIDIRULLIDE HOIDJA

DETAILIDE HOIDJA. Varre pikkus 59 cm



KÄRU VÄIKSEMATE DETAILIDE HOIDMISEKS. Mittelibisev kummist kate.

